

# JUNTORC

## JUNTA UNIVERSAL CONFORME NECESSIDADE

ESPECIFICAÇÕES TÉCNICAS  
CONFORME NORMA DIN 808

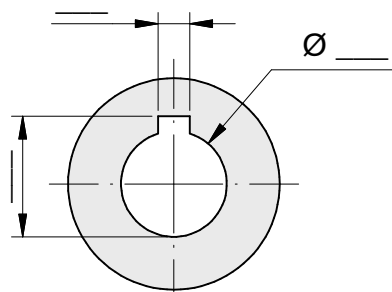
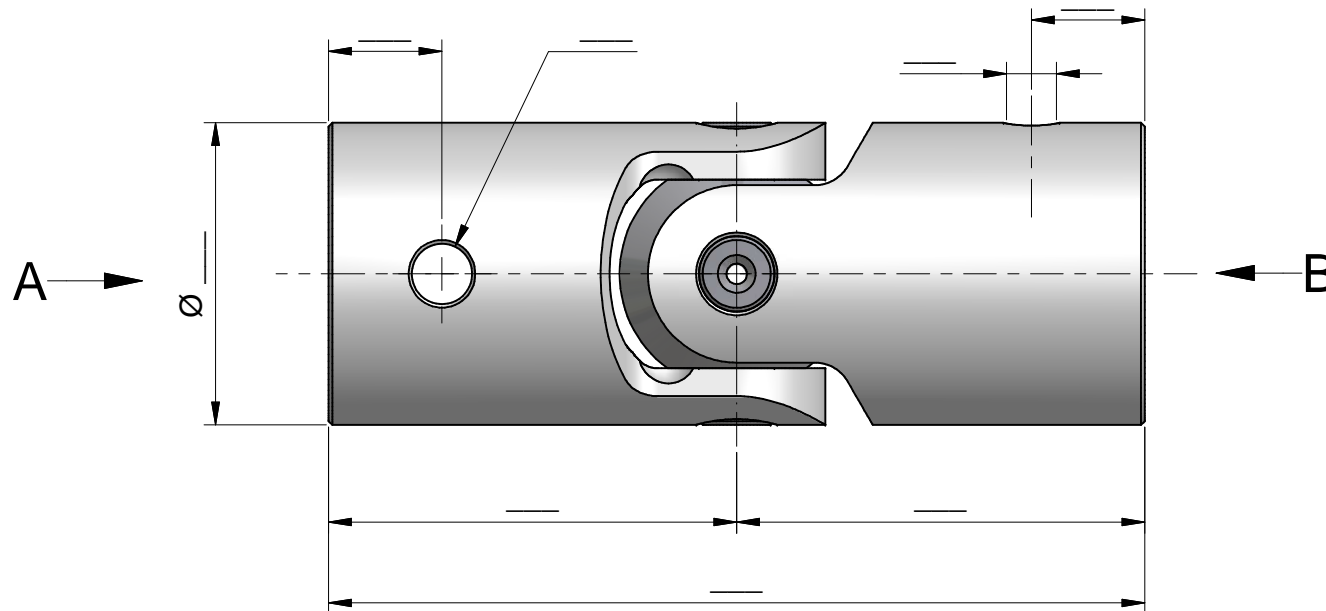
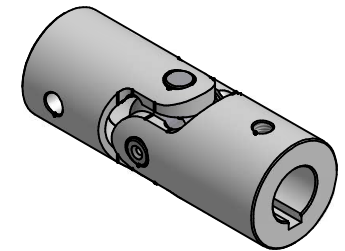

VISTA ( )

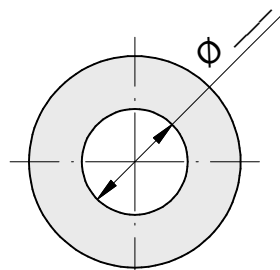

VISTA ( )

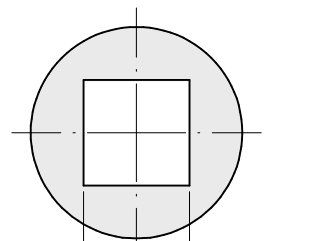

VISTA ( )

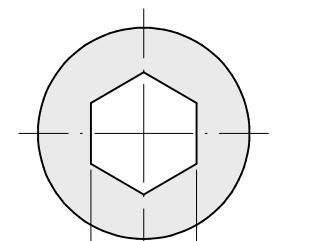

VISTA ( )

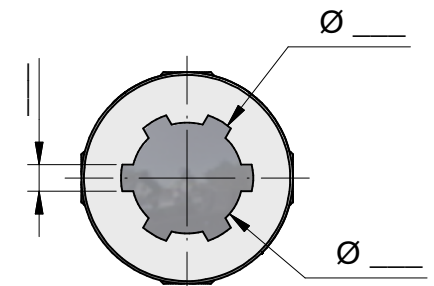

VISTA ( )